

C8108 CAM LOCK

- 4 pin tumbler
- 1 3/4" brass cylinder
- 9/32" cam offset
- for lipped applications

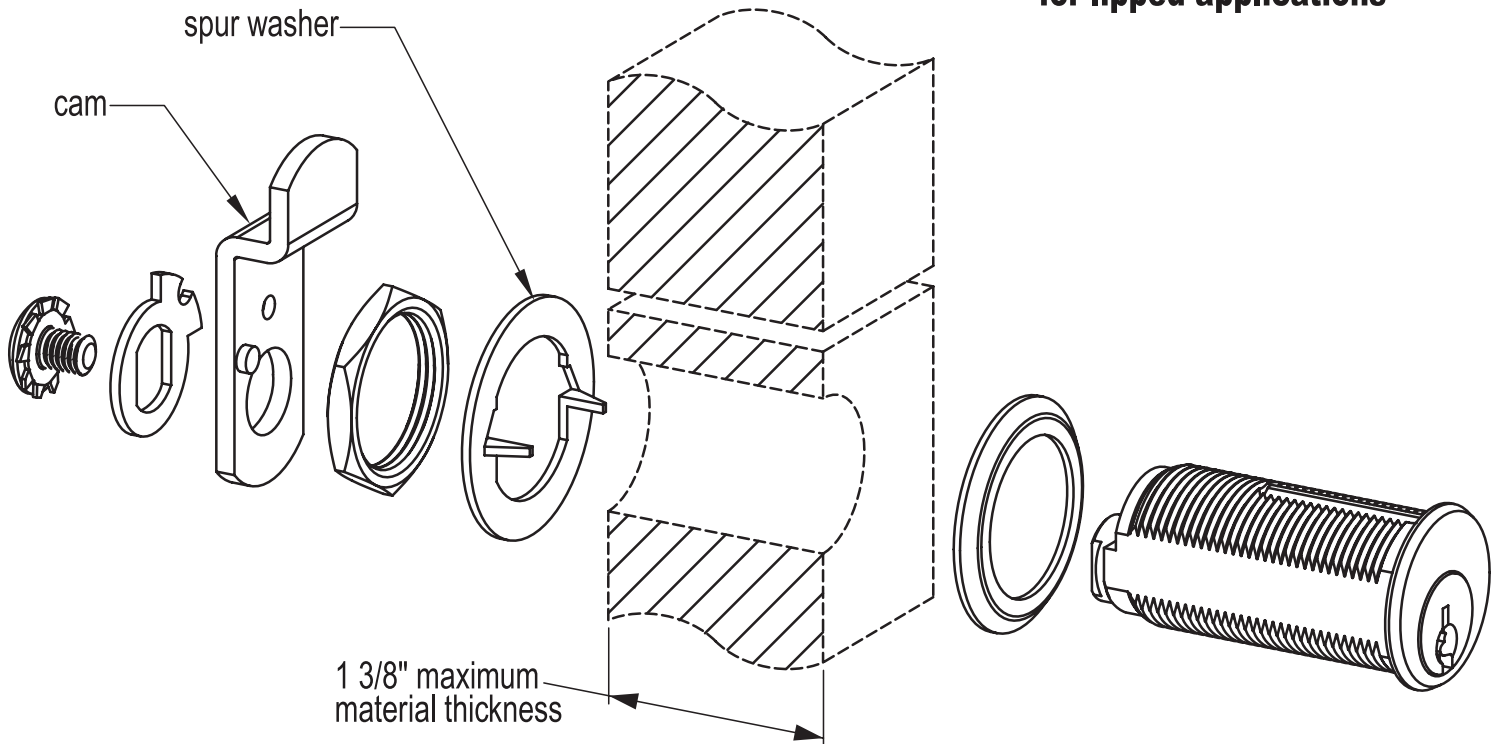

Note: cams are not reversible

Extra cam for right hand door or counter clockwise drawer use

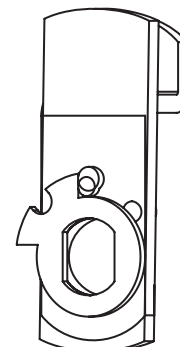
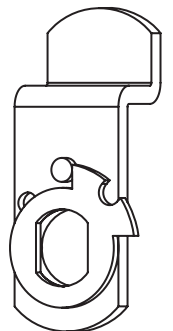

Assembled with cam for left hand door or clockwise drawer use

Cylinder mounting holes

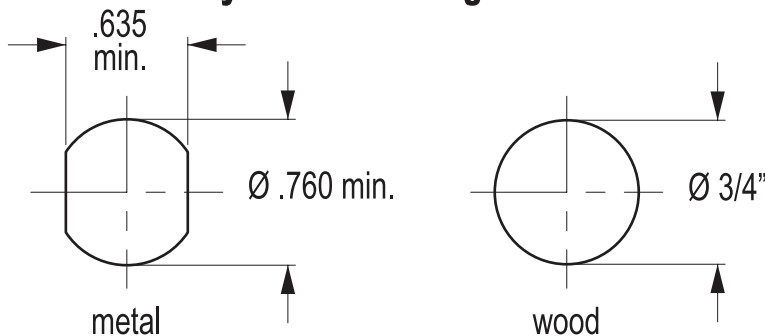

Note: Do not use spur washer with metal door or drawer